

①

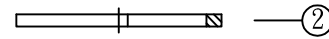

②

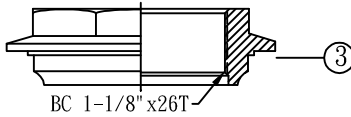

③

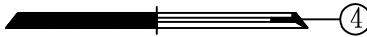

④

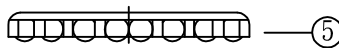

⑤

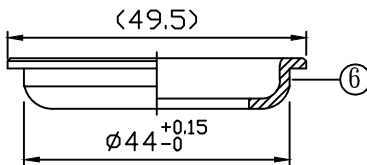

⑥

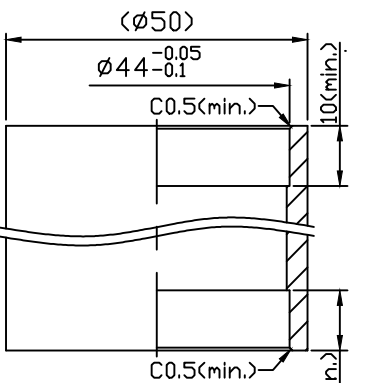

HEAD TUBE(頭管)

⑦

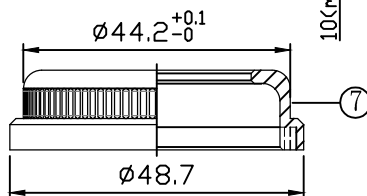

⑦



⑤

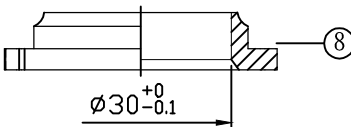

⑧

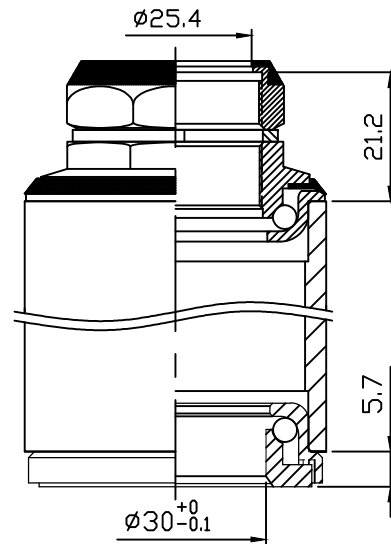

堆積高度(STACK HEIGHT)=26.9±1mm

NO.	零件名稱 PART NAME	材質 MATERIAL	圖號 DRAWING NO.	台量 Q'TY	尺寸 DIM. DESCRIPTION
1	防水上迫緊 LOCK NUT WITH SEAL	碳鋼 STEEL	841SW-1	1	BC 1-1/8" x26T
2	有領華司 KEY WASHER	碳鋼 STEEL	SK3402	1	1-1/8"
3	上塞 ADJUSTING CONE	碳鋼 STEEL	128-3	1	BC 1-1/8" x26T
4	防塵蓋 DUST-RESISTANT COVER	塑膠 NYLON	118-8	1	
5	珠巢 BALL RETAINER	碳鋼 STEEL		2	5/32" x22
6	上下碗 CUPS	碳鋼 STEEL	142-4/5	1	φ44 ^{+0.15} ₀
7	安全下碗 SAFETY LOWER CUP(130°)	碳鋼 STEEL	130SA-5	1	φ44.2 ^{+0.1} ₀
8	安全下塞 SAFETY CROWN RACE(130°)	碳鋼 STEEL	130SA-6	1	φ30 ⁺⁰ _{-0.1}

- 限制龍頭在130°範圍內旋轉之安全車頭碗組
- 半隱藏式限位車頭碗組
- 1-1/8" (28.6mm) 有牙前叉立管(BC 1-1/8" x26T)
- 車頭管內徑/外徑=44/50mm
- 整組碳鋼製品, 下半部限位
- 上下均為珠巢

- 130° safety headset
- Semi-integrated safety headset
- For 1-1/8" threaded steerer(BC 1-1/8" x26T)
- Headtube ID./OD. = 44/50mm
- Safety lower cup and safety crown race
- Ball retainers

單位 UNIT	mm	比例 SCALE	1:1	日期 DRAWING DATE	2021.06.16	角法 VIEW	
型號 ITEM NO.	H128-130SA						版次(REV):B
品名 ITEM NAME	H128-130SA組立圖(Assembly drawing)						
規格 DIMENSION	1-1/8" x44/50 x30(130°)						
圖號 FIG. NO.	H128-130SA-組立圖-B						
誌慶工業股份有限公司							